

2" & 3" DEFLECTION SPRING HANGERS

HD-S models are heavy duty hangers and incorporate a new design of steel housing, with the base's two sides bent down. This considerably increases the rigidity of the steel frame, eliminating the possibility of the bending of the frame's bottom plate under heavy loads. The top and bottom spring's rubber cups have vulcanized steel washers for even load distribution. The bottom cup has a locator rubber ring to center the cup and spring in the hanger's housing. These elastomer cups reduce the transfer of vibration and noise.



Recommended for:

Spring hangers are used for fan coil units, air circulation units, pipes, ducts, and other suspended structures and building services.

Features:

- ✓ All springs at rated load have 50% additional travel to solid load.
- ✓ Housing is yellow zinc plated for better corrosion resistance.
- ✓ Safety factor - Springs will accommodate 50% extra load from rated load to solid load.
- ✓ All hangers' elements are safe at solid load.
- ✓ Springs are color-coded and easily replaceable.
- ✓ Top and bottom elastomer cups and elements have embedded steel washer for uniform load distribution.
- ✓ New base plate design of the steel housing with two bent sides considerably increases rigidity of the frame

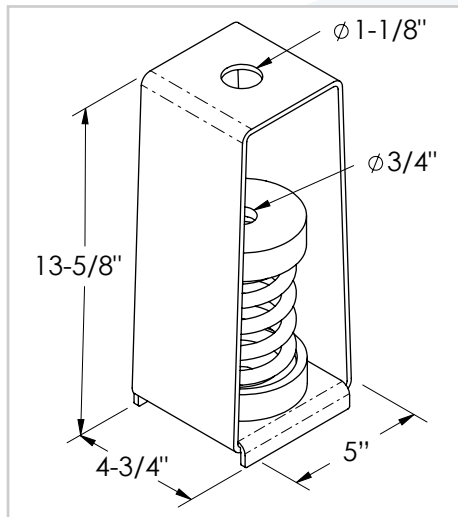

Installation Instructions:

In order to allow isolators to operate efficiently install hangers with a gap as shown below. Hangers are designed to compensate for minor misalignments.

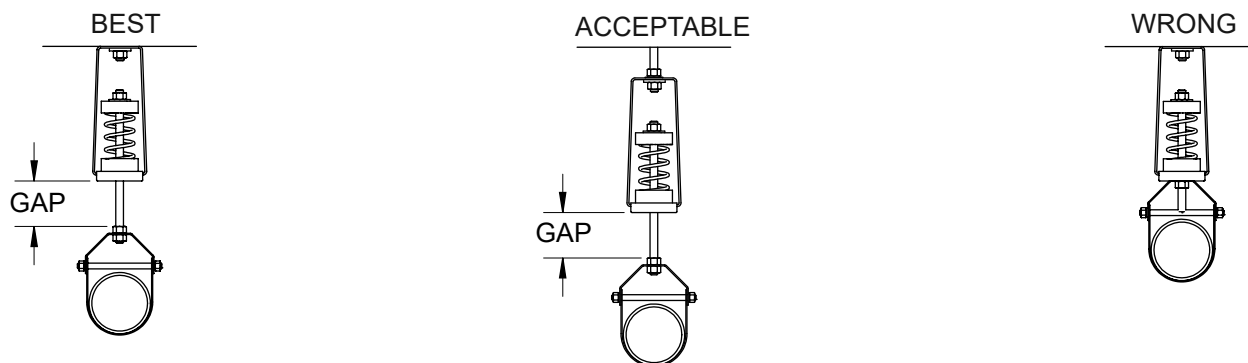

2" DEFLECTION SPRING HANGERS

Model	Rated Load (lbs)	Deflection at Rated Load (lin)	Spring Rate (lbs/in)	Spring Color
HD-S-350	80	2	40	Red
HD-S-352	125	1.8	70	Yellow
HD-S-350-140	160	2	80	Red/Black
HD-S-403	348	2	174	Black
HD-S-404	453	2	226	Blue
HD-S-405	590	2	295	Red
HD-S-406	676	2	338	Orange
HD-S-407	787	2	393	Green
HD-S-408	918	2	459	White
HD-S-409	1,000	2	500	Brown
HD-S-410	1,250	2	625	White
HD-S-407-150	1,587	2	793	Green/Grey
HD-S-409-150	1,800	2	900	Brown/Grey
HD-S-410-150	2,050	2	1,025	White/Grey

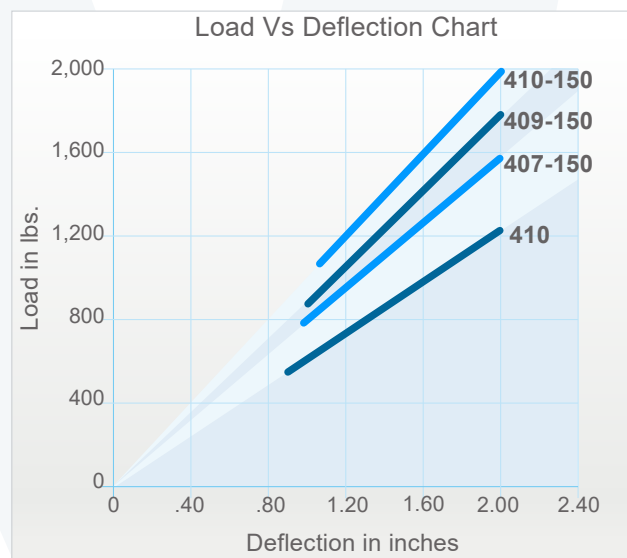
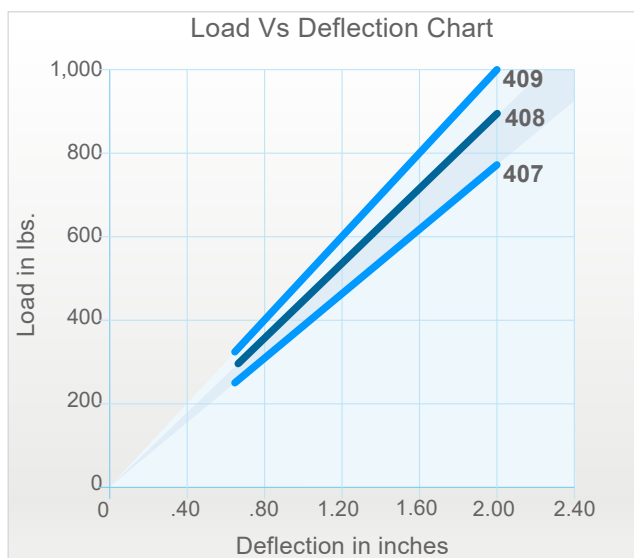
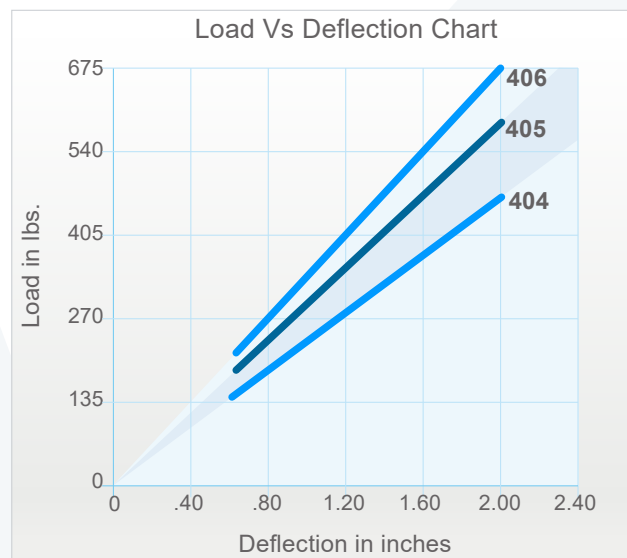
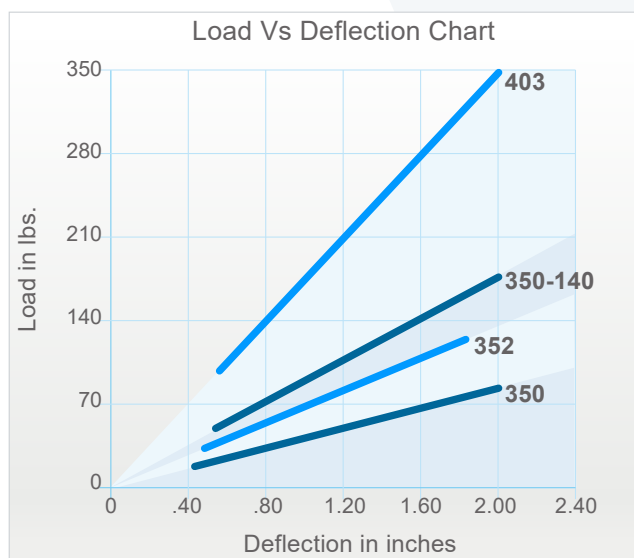

3" DEFLECTION SPRING HANGERS

Model	Rated Load (lbs)	Deflection at Rated Load (lin)	Spring Rate (lbs/in)	Spring Color
HD-S-601	140	3	47	Blue
HD-S-602	200	3	67	Yellow
HD-S-603	300	3	100	Orange
HD-S-604	450	3	150	Red

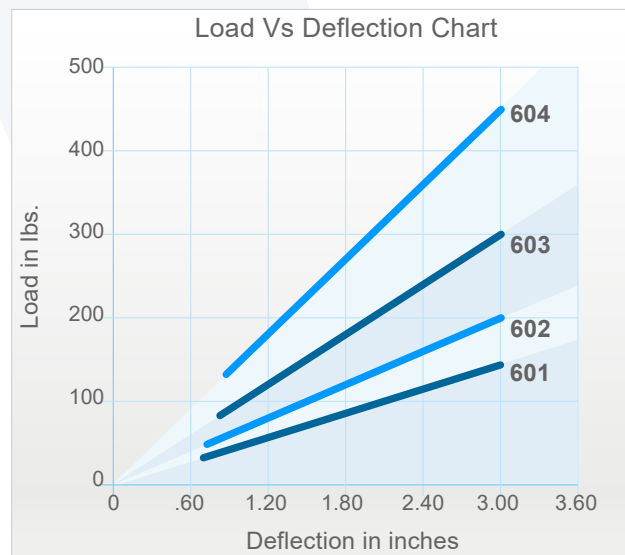

Notes:

- a) 350 Spring: 3" Outside diameter x 5" Free Length.
- b) 140 Spring: 2" Outside diameter x 5" Free Length.
- c) 400 Spring: 3" Outside diameter x 5.75" Free Length.
- d) 150 Spring: 2" Outside diameter x 5.75" Free Length.
- e) 600 Spring: 3" Outside diameter x 6.75" Free Length
- f) Rated load is the maximum load recommended.